

POLYCAB SWITCHGEARS

**INSTANT
TRIPPING***



Electrical circuits suffer from the risks of short-circuits, overloads and leakage currents, damaging your appliances and endangering lives. The all-new Instant Tripping feature of Polycab MCBs speedily recognises short circuits and trips instantly.

Bring home the guardian your home and appliances deserve.

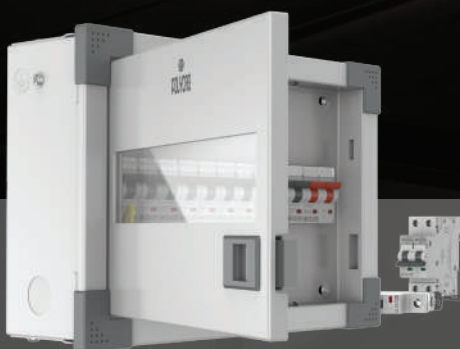
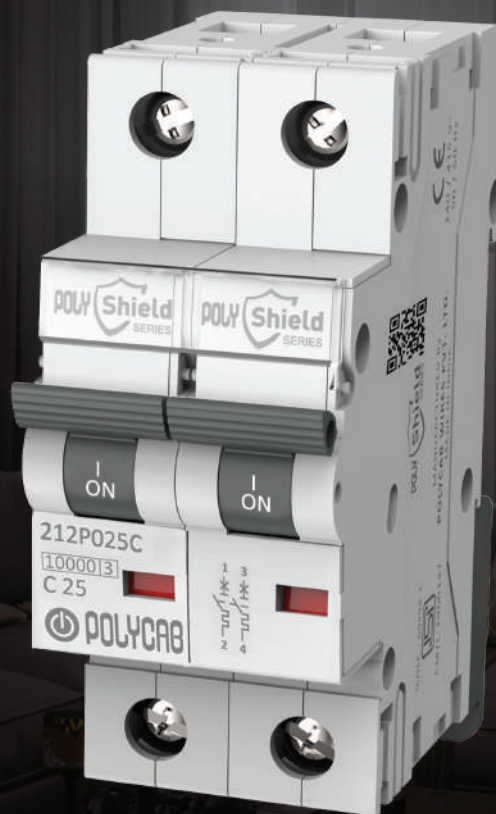

Wide Range of Switchgears,
Distribution Boards & Accessories.

*Instant Tripping feature only in the event of short circuit in accordance with IS/IEC 60898-1.

MCBs & Isolators

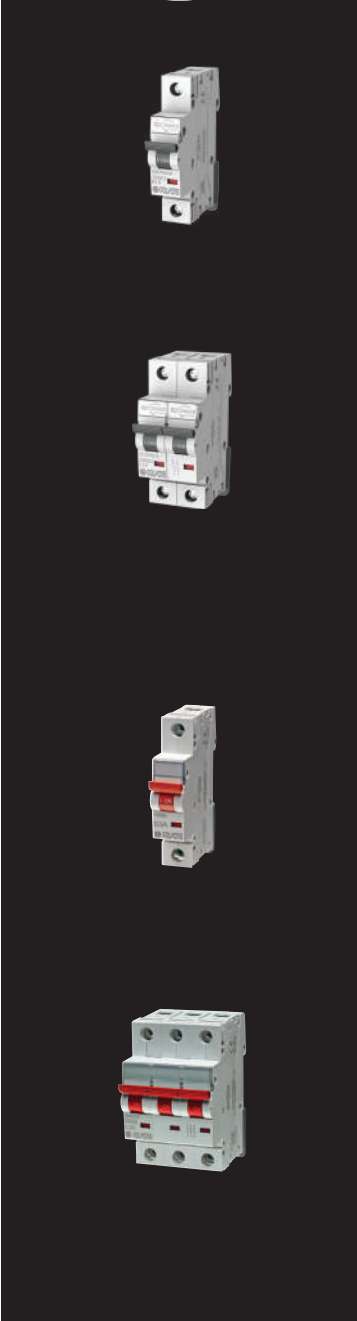

RCCB & RCBO



MCB Changeover & ACCL



Distribution Boards



MCB FEATURES



Positive Contact Position Indication:
Red and Green flag indication provided below the knob gives indication of positive electrical ON/OFF contact status irrespective of mounting or knob position even from a distance.

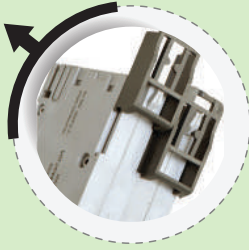

Bi-stable Din Clip Position:
Convenience of mounting on Din Rail is easy with Polycab MCB. And also, the MCBs can be easily changed from a bank of devices connected by a busbar without disturbing your existing wiring.



Enhanced Safety:
Finger proof terminals are designed to eliminate accidental contact with live part complying with IP20 protection category. Install, operate and maintain our MCBs with confidence.

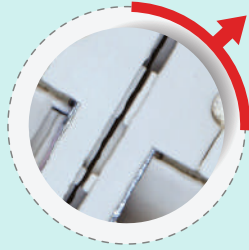

Air Flow Channel:
When two or more poles are placed adjacent to each other, the designed depression in the body cover forms a tunnel and serves as paths for air circulation thus hot air is expelled out faster resulting in reduced body temperature.

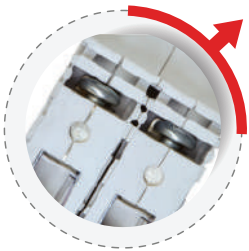

Large & Dual Terminal:
Polycab MCBs can accommodate cables upto 35sq.mm cross section area thus making it suitable for copper as well as aluminium cables. Both cable and busbar can be terminated at both the end.

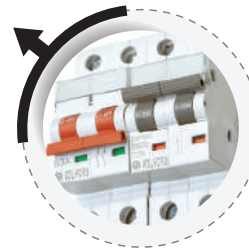

Aesthetically Designed with Safety:
Aesthetically designed Flame Retardant body ensures safety in case of accidental fire.

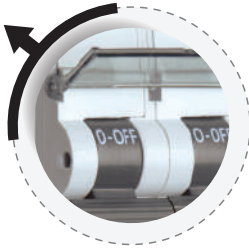

Attractive Label Holder:
Polycab MCB is provided with transparent coloured label holder which is positioned on top of the knob for inserting labels for circuit identification and hence reducing maintenance down time.

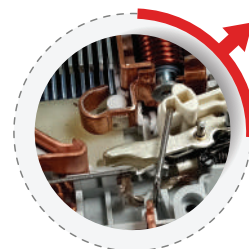

High Quality Contact Tips:
Silver graphite anti-weld contact tips ensure higher life and maximum safety against contact welding thus enhancing safety and life of the device.



Energy Limiting Class-3:
Rapid arc quenching mechanism in our MCB ensures extinguishing of the arc within quarter cycle (3 to 5 milliseconds) thus minimizing the energy flow through the circuit. This ensures minimizing risk of fire and maximizing the life of your equipment.



Energy Saver:
Power loss values upto 70% lesser than specified by IEC/IS; making Polyshield MCB one of the most energy efficient MCB.



Ease of Clamping:
Input and output clamps on the MCB is provided with combi-head screws which have both the standard slot as well as double head which can be tightened by standard screwdriver as well as Philip screwdriver thus catering to tool availability.

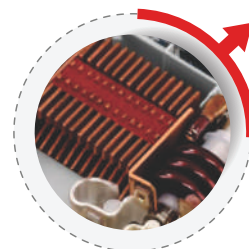

13 Plates Arc Chamber:
Quick & Efficient Arc Quenching.

MCB EXPLODED VIEW

13 plate arc chute with Quick & efficient Arc Quenching:
Improves the electrical and mechanical life

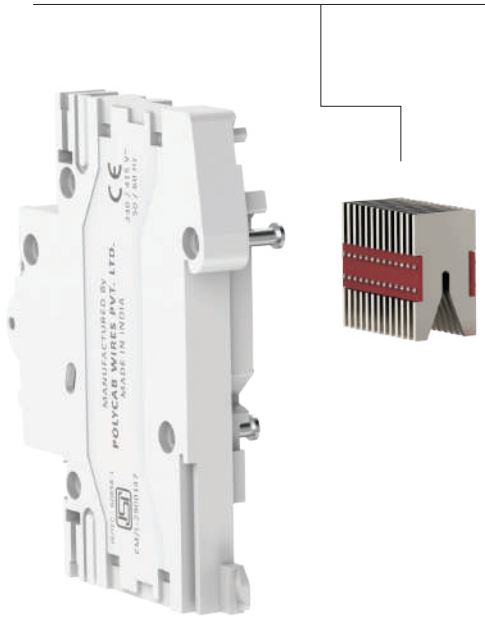

High-Grade FR Materials
With Airflow Channel:
For Safety and Durability

Anti weld Highly Durable
Contact Tip: **Ensures a
better life span**

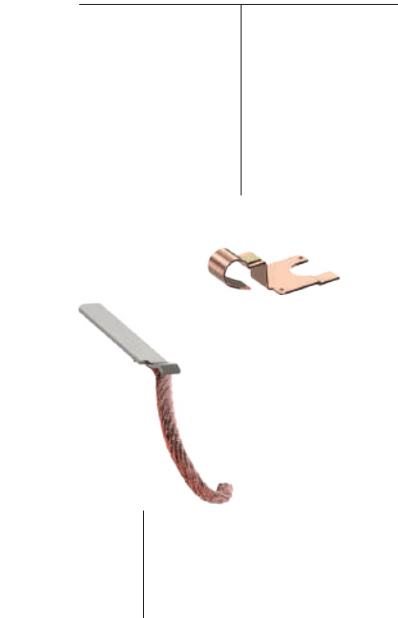

Bimetallic Strip provides:
**Smart protection against
overload**

Fast trip mechanism
confirms current limiting
class 3: **Increases
System reliability**

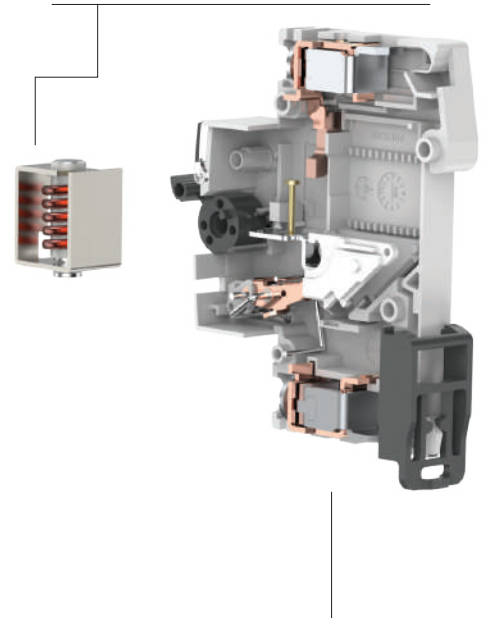

Bi connect DIN Clip &
Bi connect terminals:
**Flexible and
Easy to Install**

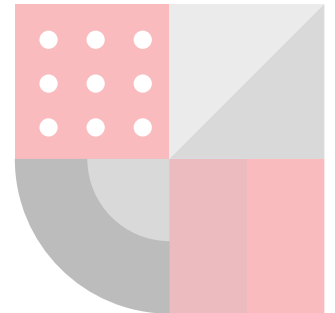
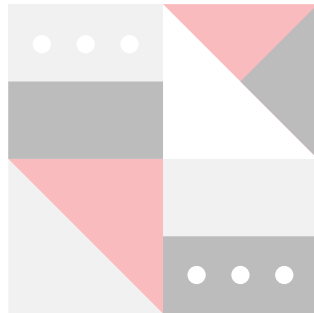
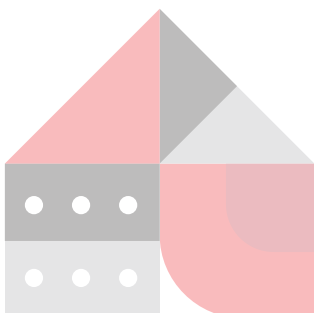

MCBs

MINIATURE CIRCUIT BREAKER (MCB)

(In accordance with IS / IEC 60898-1) 240V/ 415V AC, 50Hz, 10kA Breaking Capacity



B - Curve SP MCB			C - Curve SP MCB	
Rating (In)	Item Code	MRP/Unit ₹	Item Code	MRP/Unit ₹
6 A	GMM101P001	235/-	GMM201P001	248/-
10 A	GMM101P002	235/-	GMM201P002	248/-
16 A	GMM101P003	235/-	GMM201P003	248/-
20 A	GMM101P004	235/-	GMM201P004	248/-
25 A	GMM101P005	235/-	GMM201P005	248/-
32 A	GMM101P006	235/-	GMM201P006	248/-
40 A	GMM101P007	531/-	GMM201P007	543/-
63 A	-	-	GMM201P008	633/-

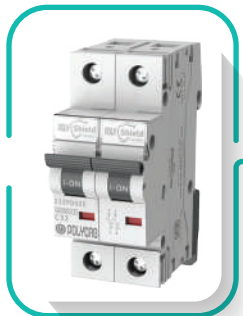

C - Curve SPN MCB			C - Curve DP MCB	
Rating (In)	Item Code	MRP/Unit ₹	Item Code	MRP/Unit ₹
6 A	GMM201N001	855/-	GMM202P001	871/-
10 A	GMM201N002	855/-	GMM202P002	871/-
16 A	GMM201N003	855/-	GMM202P003	871/-
20 A	GMM201N004	855/-	GMM202P004	871/-
25 A	GMM201N005	855/-	GMM202P005	871/-
32 A	GMM201N006	855/-	GMM202P006	871/-
40 A	GMM201N007	1,178/-	GMM202P007	1,272/-
63 A	GMM201N008	1,392/-	GMM202P008	1,408/-



C - Curve TP MCB		
Rating (In)	Item Code	MRP/Unit ₹
6 A	GMM203P001	1,410/-
10 A	GMM203P002	1,410/-
16 A	GMM203P003	1,410/-
20 A	GMM203P004	1,410/-
25 A	GMM203P005	1,410/-
32 A	GMM203P006	1,410/-
40 A	GMM203P007	1,970/-
63 A	GMM203P008	2,179/-

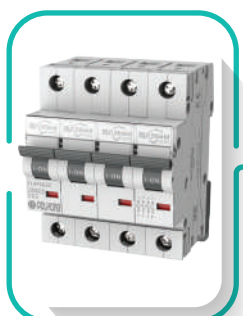

C - Curve TPN MCB			C - Curve FP MCB	
Rating (In)	Item Code	MRP/Unit ₹	Item Code	MRP/Unit ₹
6 A	GMM203N001	1,862/-	GMM204P001	1,871/-
10 A	GMM203N002	1,862/-	GMM204P002	1,871/-
16 A	GMM203N003	1,862/-	GMM204P003	1,871/-
20 A	GMM203N004	1,862/-	GMM204P004	1,871/-
25 A	GMM203N005	1,862/-	GMM204P005	1,871/-
32 A	GMM203N006	1,862/-	GMM204P006	1,871/-
40 A	GMM203N007	2,467/-	GMM204P007	2,550/-
63 A	GMM203N008	2,690/-	GMM204P008	2,784/-

Note: Packing (Primary / Secondary / Master): SP-1 / 12 / 108; DP-1 / 6 / 54; TP-1 / 4 / 36; FP-1 / 3 / 27.

MCBs

MINIATURE CIRCUIT BREAKER (MCB)

(In accordance with IS / IEC 60898-1) 240V/ 415V AC, 50Hz, 10kA Breaking Capacity



C - Curve SP MCB		
Rating (In)	Item Code	MRP/Unit ₹
0.5A	GMM201P012	400/-
1A	GMM201P013	400/-
2A	GMM201P014	400/-
3A	GMM201P015	400/-
4A	GMM201P016	400/-
5A	GMM201P017	400/-

C - Curve DP MCB	
Item Code	MRP/Unit ₹
GMM202P012	1,205/-
GMM202P013	1,205/-
GMM202P014	1,205/-
GMM202P015	1,205/-
GMM202P016	1,205/-
GMM202P017	1,205/-



C - Curve TP MCB		
Rating (In)	Item Code	MRP/Unit ₹
0.5A	GMM203P012	1,690/-
1A	GMM203P013	1,690/-
2A	GMM203P014	1,690/-
3A	GMM203P015	1,690/-
4A	GMM203P016	1,690/-
5A	GMM203P017	1,690/-

C - Curve FP MCB	
Item Code	MRP/Unit ₹
GMM204P012	2,326/-
GMM204P013	2,326/-
GMM204P014	2,326/-
GMM204P015	2,326/-
GMM204P016	2,326/-
GMM204P017	2,326/-

MINIATURE CIRCUIT BREAKER (MCB)

(In accordance with IS / IEC 60947-2) 240V/ 415V AC, 50Hz, 10kA Breaking Capacity



D - Curve SP MCB		
Rating (In)	Item Code	MRP/Unit ₹
6 A	GMM301P001	459/-
10 A	GMM301P002	459/-
16 A	GMM301P003	459/-
20 A	GMM301P004	459/-
25 A	GMM301P005	459/-
32 A	GMM301P006	459/-
40 A	GMM301P007	706/-
63 A	GMM301P008	729/-

D - Curve DP MCB	
Item Code	MRP/Unit ₹
GMM302P001	982/-
GMM302P002	982/-
GMM302P003	982/-
GMM302P004	982/-
GMM302P005	982/-
GMM302P006	982/-
GMM302P007	1,505/-
GMM302P008	1,576/-

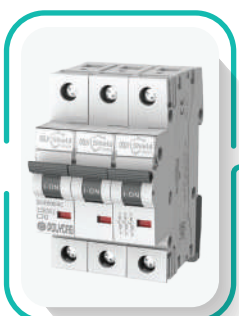

D - Curve TP MCB		
Rating (In)	Item Code	MRP/Unit ₹
6 A	GMM303P001	1,588/-
10 A	GMM303P002	1,588/-
16 A	GMM303P003	1,588/-
20 A	GMM303P004	1,588/-
25 A	GMM303P005	1,588/-
32 A	GMM303P006	1,588/-
40 A	GMM303P007	2,287/-
63 A	GMM303P008	2,311/-

D - Curve FP MCB	
Item Code	MRP/Unit ₹
GMM304P001	2,058/-
GMM304P002	2,058/-
GMM304P003	2,058/-
GMM304P004	2,058/-
GMM304P005	2,058/-
GMM304P006	2,058/-
GMM304P007	2,905/-
GMM304P008	2,964/-

Note: Packing (Primary / Secondary / Master): SP-1 / 12 / 108; DP-1 / 6 / 54; TP-1 / 4 / 36; FP-1 / 3 / 27.

MCBs

MINIATURE CIRCUIT BREAKER (MCB) for DC Installations

(In accordance with IEC 60947-2) 250Vdc per pole, 6kA Breaking Capacity



SP MCB		
Rating (In)	Item Code	MRP/Unit ₹
0.5A	GMM401P012	669/-
1A	GMM401P013	669/-
2A	GMM401P014	669/-
3A	GMM401P015	669/-
4A	GMM401P016	669/-
5A	GMM401P017	669/-
6A	GMM401P001	554/-
10A	GMM401P002	554/-
16A	GMM401P003	554/-
20A	GMM401P004	554/-
25A	GMM401P005	554/-
32A	GMM401P006	554/-
40A	GMM401P007	738/-
50A	GMM401P018	738/-
63A	GMM401P008	738/-

MINIATURE CIRCUIT BREAKER (MCB) for DC Installations

(In accordance with IEC 60947-2) 250Vdc per pole, 6kA Breaking Capacity

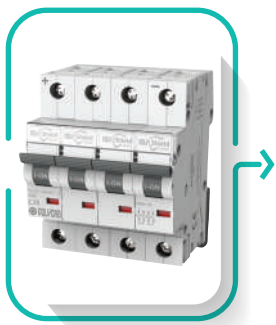

DP MCB			FP MCB	
Rating (In)	Item Code	MRP/Unit ₹	Item Code	MRP/Unit ₹
0.5A	GMM402P012	1,327/-	GMM404P012	2,665/-
1A	GMM402P013	1,327/-	GMM404P013	2,665/-
2A	GMM402P014	1,327/-	GMM404P014	2,665/-
3A	GMM402P015	1,327/-	GMM404P015	2,665/-
4A	GMM402P016	1,327/-	GMM404P016	2,665/-
5A	GMM402P017	1,327/-	GMM404P017	2,665/-
6A	GMM402P001	1,154/-	GMM404P001	2,365/-
10A	GMM402P002	1,154/-	GMM404P002	2,365/-
16A	GMM402P003	1,154/-	GMM404P003	2,365/-
20A	GMM402P004	1,154/-	GMM404P004	2,365/-
25A	GMM402P005	1,154/-	GMM404P005	2,365/-
32A	GMM402P006	1,154/-	GMM404P006	2,365/-
40A	GMM402P007	1,575/-	GMM404P007	3,149/-
50A	GMM402P018	1,575/-	GMM404P018	3,149/-
63A	GMM402P008	1,575/-	GMM404P008	3,149/-

Mini DP MINIATURE CIRCUIT BREAKER (MCB) with Enclosure



MINI DP MCB WITH ENCLOSURE		
Description	Item Code	MRP/Unit ₹
16A DP C MINI MCB withFR Encloser	GMM102E003	629/-
20A DP C MINI MCB with FR Encloser	GMM102E004	629/-
25A DP C MINI MCB withFR Encloser	GMM102E005	629/-
32A DP C MINI MCB with FR Encloser	GMM102E006	629/-

Note: Packing (Primary / Secondary / Master): SP-1 / 12 / 108; DP-1 / 6 / 54; FP-1 / 3 / 27.

ISOLATORS

MCB ISOLATORS

(In accordance with IS / IEC 60947-3) 240V/ 415V AC, 50Hz, AC - 22A

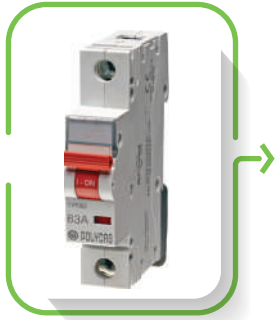

SP		
Rating (In)	Item Code	MRP/Unit ₹
40A	GMS501P001	406/-
63A	GMS501P002	472/-

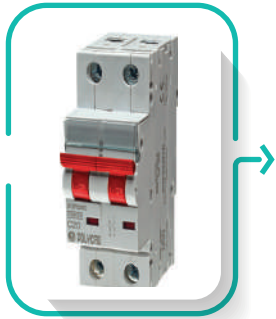

DP		
Rating (In)	Item Code	MRP/Unit ₹
40A	GMS502P001	600/-
63A	GMS502P002	735/-
80A	GMS502P003	957/-
100A	GMS502P004	967/-
125A	GMS502P005	1003/-

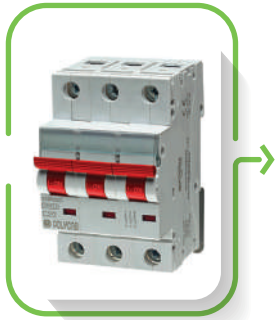

TP			FP	
Rating (In)	Item Code	MRP/Unit ₹	Item Code	MRP/Unit ₹
40A	GMS503P001	907/-	GMS504P001	1,209/-
63A	GMS503P002	1,108/-	GMS504P002	1,403/-
80A	GMS503P003	1,390/-	GMS504P003	1,947/-
100A	GMS503P004	1,451/-	GMS504P004	1,947/-
125A	GMS503P005	1,451/-	GMS504P005	2,078/-

Note: Packing (Primary / Secondary / Master): SP-1 / 12 / 108; DP-1 / 6 / 54; TP-1 / 4 / 36; FP-1 / 3 / 27.

DIMENSION DETAILS OF MCB's / ISOLATORS

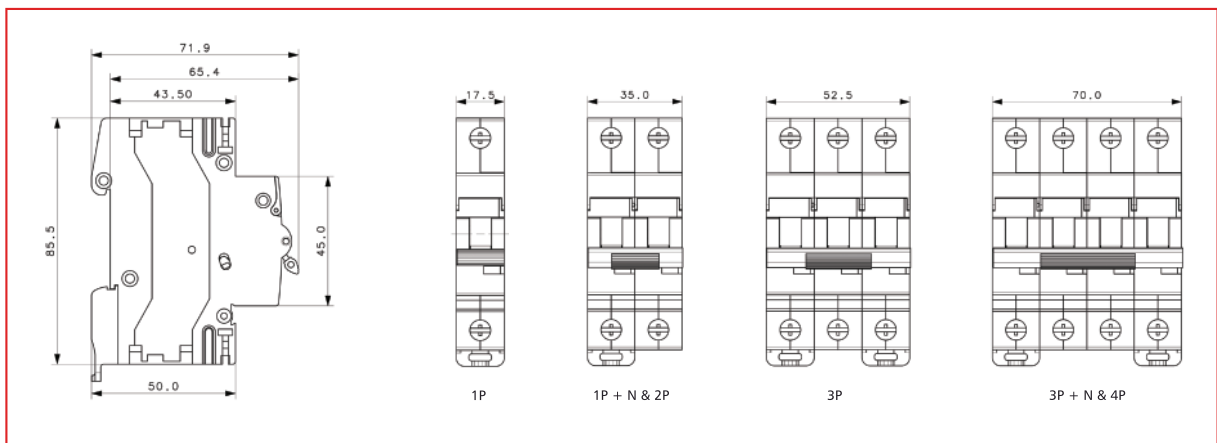

MCB CHANGEOVER

MCB Changeover Switch

(In accordance with IS/IEC 60947-3)



DP		
Rating (In)	Item Code	MRP/Unit ₹
25A	GMC102P001	1,233/-
40A	GMC102P002	1,626/-
63A	GMC102P003	2070/-

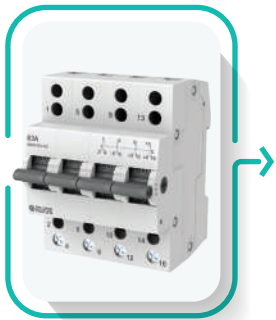

FP		
Rating (In)	Item Code	MRP/Unit ₹
25A	GMC104P001	2,489/-
40A	GMC104P002	3,277/-
63A	GMC104P003	4,190/-

Note: Packing (Primary / Secondary / Master): DP-1 / 6 / 54; FP-1 / 3 / 27.

Connection Diagram

Two Pole

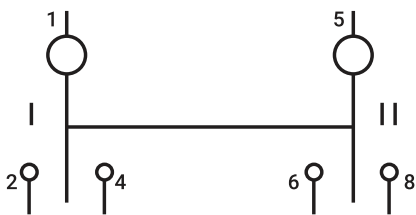

"I" - Incoming terminals (main supply 2 & 6)
 "II" - Incoming terminals (standby supply 4 & 8)
 Outgoing terminals (to load 1 & 5)
 Mid position of Knob is OFF position

Four Pole

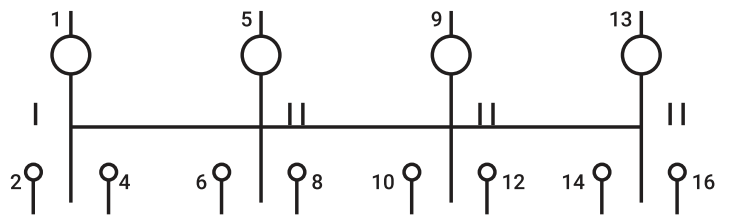

"I" - Incoming terminals (main supply 2, 6, 10 & 14)
 "II" - Incoming terminals (standby supply 4, 8, 12 & 16)
 Outgoing terminals (to load 1, 5, 9 & 13)
 Mid position of Knob is OFF position

RCCB FEATURES



Test button

Allows you to periodically check the health of the device.

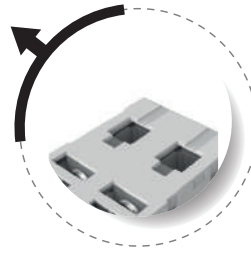

Large & Dual Termination

It accommodates cables up to 35sq.mm thus making it suitable for copper as well as aluminium cables. Both cables and busbars can be terminated on either side.



Combi-head Screw

Allows for clamping or tightening of the screws using either a flat or philips head screwdriver.

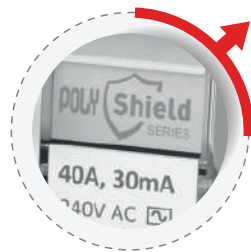

Label Holder

A transparent label holder positioned above the knob allows insertion of labels for easy circuit identification.



Advance Neutral

Neutral circuit closes first while making a connection & opens last while disconnecting a circuit.

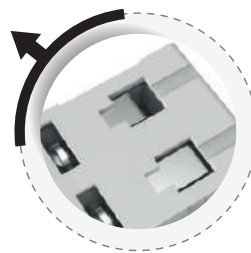

Safety Terminal

Terminals are equipped with a shutter to avoid wrong wire entry during installation.



Real Trip Indicator

Provides a real indication of the RCCB tripping due to a fault in the circuit.

■ White - On / Off Indication

■ Red - Trip Indication

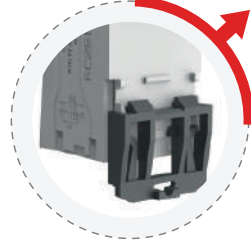

Easy Extraction

A unique mounting assembly allows removal of the unit without disturbing other devices or having to dismantle the busbar.



Locked Knob

Allow the unit to be locked OFF for safety while carrying out maintenance & locked ON for critical loads.

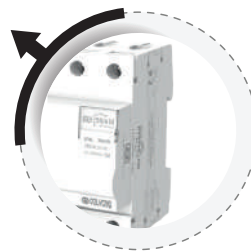

Cooler Operation

A specially designed depression forms a tunnel when units are installed adjacent to each other allowing hot air to be expelled faster, resulting in a lower body temperature.



Protection from Leakage Currents

Reduced risks of fire hazards & electrocution due to leakage current from poorly insulated apparatus or faulty wires.

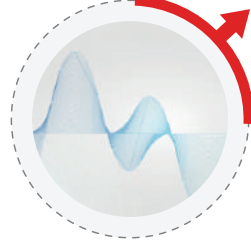

Operates Irrespective of Supply Voltage

The unit protects against earth leakages & faults irrespective of the supply voltage due to the RCCBs electromechanical design.

RCCB APPLICATION



RCCBs can be used in a wide array of applications. Selection is based on the degree of protection required and current sensitivities.

- **30mA RCCB**

For protection against direct contact or electrical shocks

- **100mA RCCB**

For protection against indirect contact, in large or old installations where natural leakage is high

- **300mA RCCB**

For protection against fire, insulation faults in commercial & industrial installations

INTERNAL VIEW RCCB

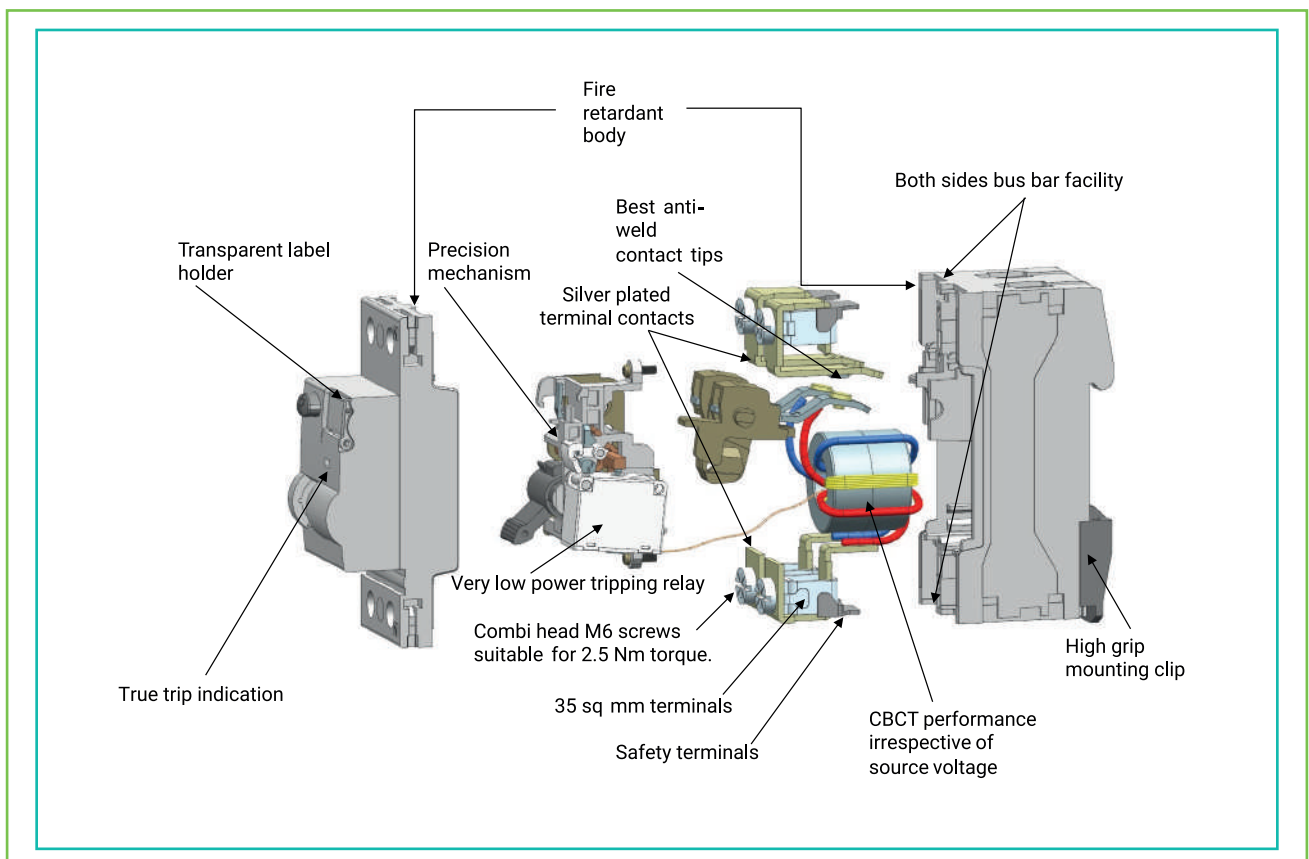

RESIDUAL CURRENT CIRCUIT BREAKER (RCCB)

RESIDUAL CURRENT CIRCUIT BREAKER (RCCB)

(In accordance with IS 12640-1, IEC 61008-1)

DP			
Rating (In)	Sensitivity	Item Code	MRP/Unit ₹
25A	30mA	GMR502P003	3,075/-
25A	100mA	GMR502P009	3,182/-
25A	300mA	GMR502P015	3,182/-
40A	30mA	GMR502P005	3,407/-
40A	100mA	GMR502P011	3,467/-
40A	300mA	GMR502P017	3,467/-
63A	30mA	GMR502P006	4,333/-
63A	100mA	GMR502P012	4,381/-
63A	300mA	GMR502P018	4,381/-

FP			
Rating (In)	Sensitivity	Item Code	MRP/Unit ₹
25A	30mA	GMR504P003	4,025/-
25A	100mA	GMR504P009	4,096/-
25A	300mA	GMR504P015	4,096/-
40A	30mA	GMR504P005	4,108/-
40A	100mA	GMR504P011	4,179/-
40A	300mA	GMR504P017	4,179/-
63A	30mA	GMR504P006	4,571/-
63A	100mA	GMR504P012	4,630/-
63A	300mA	GMR504P018	4,630/-

RESIDUAL CURRENT CIRCUIT BREAKER WITH OVER CURRENT PROTECTION (RCBO)

(In accordance with IS 12640-2, IEC 61009-1)

DP			
Rating (In)	Sensitivity	Item Code	MRP/Unit ₹
6A	30mA	GMB101N001	4,286/-
6A	100mA	GMB201N001	4,446/-
6A	300mA	GMB301N001	4,446/-
10A	30mA	GMB101N002	4,286/-
10A	100mA	GMB201N002	4,446/-
10A	300mA	GMB301N002	4,446/-
16A	30mA	GMB101N003	4,286/-
16A	100mA	GMB201N003	4,446/-
16A	300mA	GMB301N003	4,446/-
20A	30mA	GMB101N004	4,286/-
20A	100mA	GMB201N004	4,446/-
20A	300mA	GMB301N004	4,446/-
25A	30mA	GMB101N005	4,286/-
25A	100mA	GMB201N005	4,446/-
25A	300mA	GMB301N005	4,446/-
32A	30mA	GMB101N006	4,286/-
32A	100mA	GMB201N006	4,446/-
32A	300mA	GMB301N006	4,446/-
40A	30mA	GMB101N007	4,600/-
40A	100mA	GMB201N007	4,725/-
40A	300mA	GMB301N007	4,725/-
63A	30mA	GMB101N008	5,520/-
63A	100mA	GMB201N008	5,639/-
63A	300mA	GMB301N008	5,639/-

RESIDUAL CURRENT CIRCUIT BREAKER (RCCB)

RESIDUAL CURRENT CIRCUIT BREAKER WITH OVER CURRENT PROTECTION (RCBO)

(In accordance with IS 12640-2, IEC 61009-1)

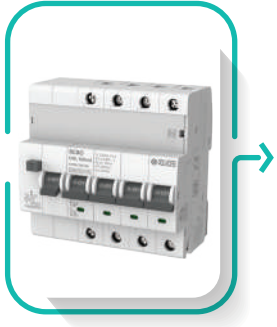

FP			
Rating (In)	Sensitivity	Item Code	MRP/Unit ₹
6A	30mA	GMB103N001	5,592/-
6A	100mA	GMB203N001	5,081/-
6A	300mA	GMB303N001	5,081/-
10A	30mA	GMB103N002	5,592/-
10A	100mA	GMB203N002	5,081/-
10A	300mA	GMB303N002	5,081/-
16A	30mA	GMB103N003	5,592/-
16A	100mA	GMB203N003	5,081/-
16A	300mA	GMB303N003	5,081/-
20A	30mA	GMB103N004	5,592/-
20A	100mA	GMB203N004	5,081/-
20A	300mA	GMB303N004	5,081/-
25A	30mA	GMB103N005	5,592/-
25A	100mA	GMB203N005	5,081/-
25A	300mA	GMB303N005	5,081/-
32A	30mA	GMB103N006	5,592/-
32A	100mA	GMB203N006	5,081/-
32A	300mA	GMB303N006	5,081/-
40A	30mA	GMB103N007	5,663/-
40A	100mA	GMB203N007	5,378/-
40A	300mA	GMB303N007	5,378/-
63A	30mA	GMB103N008	6,090/-
63A	100mA	GMB203N008	6,227/-
63A	300mA	GMB303N008	6,227/-

Note: Packing (Primary / Secondary / Master): 1 / NA / 8.

AUTOMATIC CHANGEOVER WITH CURRENT LIMITER (ACCL)

(In accordance with IEC 60947-3, IEC60947-6) 240V, 50Hz & Conditional short circuit current 5kA



SINGLE PHASE ACCL			
ACCL Genset Current Rating	ACCL Main Current	Item Code	MRP/Unit ₹
0.5A	30A	GMC30SP005	3,105/-
1A	30A	GMC30SP010	3,105/-
1.5A	30A	GMC30SP015	3,105/-
2.5A	30A	GMC30SP025	3,105/-
3A	30A	GMC30SP030	3,105/-
4A	30A	GMC30SP040	3,105/-
5A	30A	GMC30SP050	3,105/-
6A	30A	GMC30SP060	3,105/-
8A	30A	GMC30SP080	3,105/-
9A	30A	GMC30SP090	3,105/-
10A	30A	GMC30SP100	3,105/-
15A	30A	GMC30SP150	3,105/-
20A	30A	GMC30SP200	3,105/-
25A	30A	GMC30SP250	3,105/-
30A	30A	GMC30SP300	3,105/-

Note: Packing (Primary / Secondary / Master): 1 / NA / 18.

Overall Mechanical Dimensions

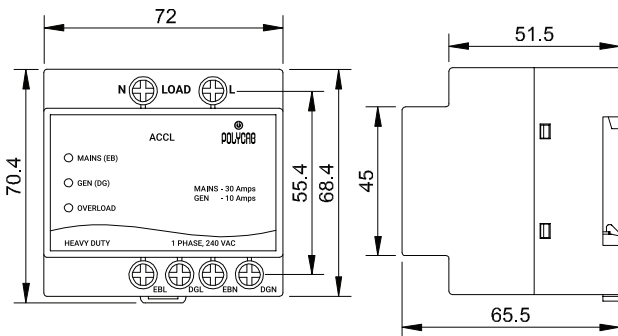

Recommended Load Connections

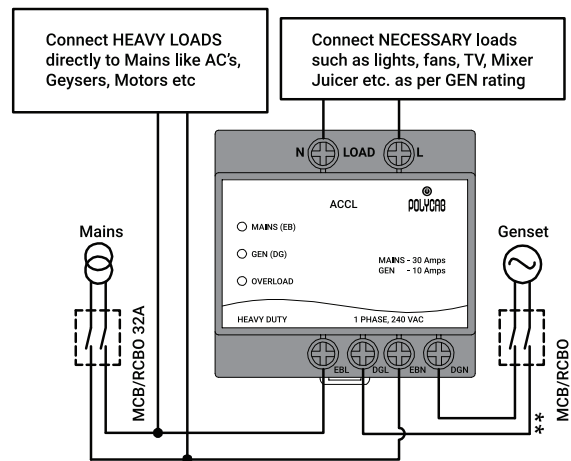

SALIENT FEATURES

- **Safe** : IP20 protection and environment friendly FR body material
- **Technical Superiority** : Unique Contactor based technology, break before make changeover contact with higher air gap
- **Convenient** : Auto Reset Facility
- **Reliable** : Conditional short circuit current capacity 5kA
- **Low Power Consumption** : Power consumed is less than 0.2VA during Mains supply & 15VA during generator operation
- **Long Life** : 25,000 Electrical Operations
- **Heavy Duty** : Utilisation category AC22A (IEC 60947-3) & AC32A (IEC 60947-6)
- **Compact** : Can be fitted with Polycab MCB range DIN Rail mounted
- **Alert** : Overload indication on Genset side by LED and BEEP

POLYCAB DISTRIBUTION BOARDS



SAFETY @ HOME



Designed to suit
your interiors



Protection from
dust and water



Optimized
dimensions with
removable
top & bottom
gland plates

DISTRIBUTION BOARDS

MCB ENCLOSURE

(In accordance with IS 13032, IS 8623, IEC / BSEN 61439-3)
(RAL - 9003 fine white texture)



In sheet steel, suitable for 2P/4P devices			
No. of Ways	No. of Poles	Item Code	MRP/ Unit ₹
2W	DP	GPDSN10002	510/-
4W	FP	GPDTN10002	570/-



MCB ENCLOSURE (Plastic)

(In accordance with IS 13032, IS 8623)

Description	Item Code	MRP/ Unit ₹
1/2 Pole MCB Plastic Enclosure	GPDSN1P002	123/-
3/4 Pole MCB Plastic Enclosure	GPDSN1P004	196/-

PLUG & SOCKETS DISTRIBUTION BOARD

(In accordance with IS 13032, IS 8623, IEC / BSEN 61439-3)
(RAL - 9003 fine white texture)



Plug & Socket Board, with Metal Plug & Socket, 1P+N/3P & Earth			
Rating	No. of Poles	Item Code	MRP/ Unit ₹
20A	SP	GPDPS10006	1,093/-
20A	DP	GPDPS10004	1,531/-
20A	TP	GPDPS10005	2,038/-
30A	TP	GPDPS20003	3,370/-

Note: Packing (Primary / Master): SPN (4 Way / 6 Way / 8 Way) - 1 / 6, SPN (12 Way / 16 Way) - 1 / 4.

SPN DISTRIBUTION BOARD

(In accordance with IS 13032, IS 8623, IEC / BSEN 61439-3)
(RAL - 9003 fine white texture, IP 30 - Single Door DB)

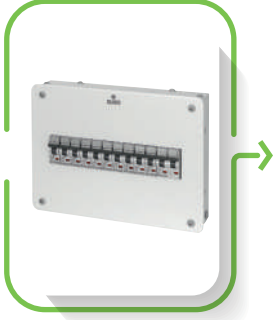

SPN Distribution Board (Suitable for DP Incoming and SP Outgoing)		
No. of Ways	Item Code Single Door	MRP/Unit ₹
4W	GPDSN10016	1,203/-
6W	GPDSN10017	1,332/-
8W	GPDSN10018	1,439/-
12W	GPDSN10019	1,949/-
16W	GPDSN10020	2,412/-

TPN DISTRIBUTION BOARD

(In accordance with IS 13032, IS 8623, IEC / BSEN 61439-3)
(RAL - 9003 fine white texture, IP 30 - Single Door DB)

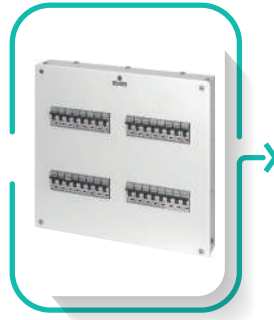

TP&N Distribution Board (Suitable for FP Incoming and SP Outgoing)			
No. of Ways	I/C + O/G Ways	Item Code Single Door	MRP/Unit ₹
4W	4 + 12	GPDTN10031	3,475/-
4W	8 + 12	GPDTN10032	3,538/-
6W	8 + 18	GPDTN10033	4,224/-
8W	8 + 24	GPDTN10034	4,862/-
12W	8 + 36	GPDTN10030	6,322/-

SPN DISTRIBUTION BOARD

(RAL - 9003 fine white texture, IP 42 - Double Door DB)

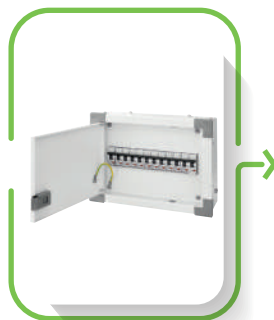

SPN Distribution Board (Suitable for DP Incoming and SP Outgoing)		
No. of Ways	Item Code Double Door	MRP/Unit ₹
4W	GPDSN20016	1,839/-
6W	GPDSN20012	2,130/-
8W	GPDSN20017	2,323/-
12W	GPDSN20018	2,844/-
16W	GPDSN20019	3,751/-

Note: Packing (Primary / Master): SPN (4 Way / 6 Way / 8 Way) - 1 / 6, SPN (12 Way / 16 Way) - 1 / 4.

TPN DISTRIBUTION BOARD

(RAL - 9003 fine white texture, IP 42 - Double Door DB)

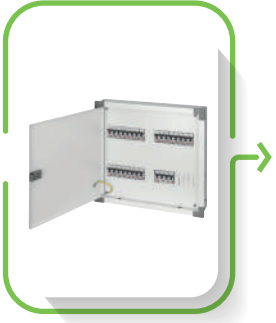

TPN Distribution Board (Suitable for FP Incoming and SP Outgoing)			
No. of Ways	I/C + O/G Ways	Item Code Double Door	MRP/Unit ₹
4W	4 + 12	GPDTN20064	4,477/-
4W	8 + 12	GPDTN20065	4,695/-
6W	8 + 18	GPDTN20066	5,675/-
8W	8 + 24	GPDTN20067	7,154/-
12W	8 + 36	GPDTN20068	10,919/-

SPN ACRYLIC DISTRIBUTION BOARD

(RAL - 9003 fine white texture, IP 42 - Double Door DB)

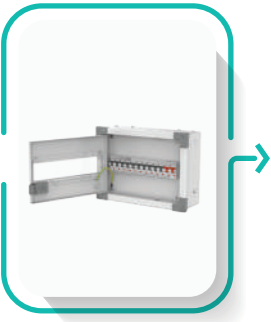

SPN Distribution Board (Suitable for DP Incoming and SP Outgoing)		
No. of Ways	Item Code Double Door	MRP/Unit ₹
4W	GPDSN30006	2,125/-
6W	GPDSN30007	2,566/-
8W	GPDSN30008	2,863/-
12W	GPDSN30009	3,549/-
16W	GPDSN30010	4,744/-

TPN ACRYLIC DISTRIBUTION BOARD

(RAL - 9003 fine white texture, IP 42 - Double Door DB)



TPN Distribution Board (Suitable for FP Incoming and SP Outgoing)			
No. of Ways	I/C + O/G Ways	Item Code Single Door	MRP/Unit ₹
4W	4 + 12	GPDTN30006	5,834/-
4W	8 + 12	GPDTN30007	6,275/-
6W	8 + 18	GPDTN30008	7,885/-
8W	8 + 24	GPDTN30009	10,228/-
12W	8 + 36	GPDTN30010	12,537/-

Note: Packing (Primary / Master): SPN (4 Way / 6 Way / 8 Way) - 1 / 6, SPN (12 Way / 16 Way) - 1 / 4.

TPN VERTICAL DISTRIBUTION BOARD

(In accordance with IS 13032, IS 8623, IEC / BSEN 61439-3)

RAL - 9003 fine white texture, IP 42 - Double Door DB



TPN Vertical Distribution Board (Suitable for FP Incoming and SP / TP Outgoing)			
No. of Ways	I/C + O/G Ways	Item Code Double Door	MRP/Unit ₹
4W	8 + 12	GPDTN20069	12,279/-
6W	8 + 18	GPDTN20070	13,755/-
8W	8 + 24	GPDTN20071	15,348/-
12W	8 + 36	GPDTN20072	19,910/-

TPN PPI HORIZONTAL DISTRIBUTION BOARD

(In accordance with IS 13032, IS 8623, IEC / BSEN 61439-3)

RAL - 9003 fine white texture, IP 42 - Double Door DB

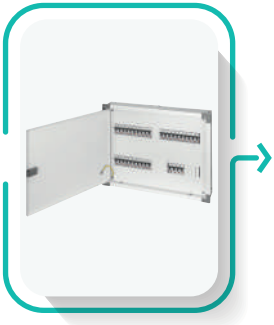

TP&N Distribution Board, Per Phase Isolated Neutral (Suitable for FP Incoming and SP Outgoing)			
No. of Ways	I/C + O/G Ways	Item Code Double Door	MRP/Unit ₹
4W	8 + 6 + 12	GPDTN20077	7,029/-
6W	8 + 6 + 18	GPDTN20078	9,070/-
8W	8 + 6 + 24	GPDTN20079	10,803/-
12W	8 + 6 + 36	GPDTN20080	13,063/-

TPN PPI VERTICAL DISTRIBUTION BOARD

(In accordance with IS 13032, IS 8623, IEC / BSEN 61439-3)

RAL - 9003 fine white texture, IP 42 - Double Door DB



TP&N Distribution Board, Per Phase Isolated Neutral (Suitable for FP Incoming and SP Outgoing)			
No. of Ways	I/C + O/G Ways	Item Code Double Door	MRP/Unit ₹
4W	8 + 6 + 12	GPDTN20046	6,786/-
6W	8 + 6 + 18	GPDTN20047	9,793/-
8W	8 + 6 + 24	GPDTN20048	14,359/-
12W	8 + 6 + 36	GPDTN20049	17,862/-

FLEXY TIER DISTRIBUTION BOARD

Flexibility of choosing Incomer & Outgoing as per your requirement,

RAL - 9003 fine white texture, IP 42 - Double Door DB



Distribution Board, With Total Installation Flexibility			
No. of Ways	No. of Modules	Item Code Double Door	MRP/Unit ₹
2 Row of 12 Mod	24	GPDTN20052	4,804/-
3 Row of 12 Mod	36	GPDTN20053	6,308/-
4 Row of 10 Mod	40	GPDTN20054	7,892/-
4 Row of 14 Mod	56	GPDTN20055	8,882/-

TPN PHASE SELECTOR (VERTICAL)

(In accordance with IS 13032, IS 8623, IEC / BSEN 61439-3)

RAL - 9003 fine white texture, IP 42 - Double Door DB



Suitable for 8 Way Incomer and SP Outgoing with Rotary Switches (Manual Operated)			
Selector Rating	No. of Ways	Item Code Double Door	MRP/Unit ₹
40A	4 Way	GPDTN30021	13,639/-
63A	4 Way	GPDTN30022	16,143/-
40A	6 Way	GPDTN30023	13,868/-
63A	6 Way	GPDTN30024	16,160/-
40A	8 Way	GPDTN30025	15,427/-
63A	8 Way	GPDTN30026	17,150/-

TPN DISTRIBUTION BOARD, 7 SEGMENT

(In accordance with IS 13032, IS 8623, IEC / BSEN 61439-3)

RAL - 9003 fine white texture, IP 42 - Double Door DB



Suitable for FP Incoming and SP Outgoing with Provision of DP RCCB Protection			
No. of Ways	I/C + O/G Ways	Item Code Double Door	MRP/Unit ₹
4W	8 + 6 + 12	GPDTN20073	11,269/-
6W	8 + 6 + 18	GPDTN20074	13,451/-
8W	8 + 6 + 24	GPDTN20075	17,254/-
12W	8 + 6 + 36	GPDTN20076	18,927/-

TPN DISTRIBUTION BOARD, 8 SEGMENT

(In accordance with IS 13032, IS 8623, IEC / BSEN 61439-3)

RAL - 9003 fine white texture, IP 42 - Double Door DB



Suitable for FP Incoming and SP Outgoing with Provision of DP RCCB Protection		
No. of Ways	Item Code Double Door	MRP/Unit ₹
4W	GPDTN20083	11,530/-
6W	GPDTN20084	13,763/-
8W	GPDTN20085	17,651/-
12W	GPDTN20086	19,366/-

TV TEL DISTRIBUTION BOARD

(In accordance with IS 13032, IS 8623, IEC / BSEN 61439-3)

RAL - 9003 fine white texture, IP 42 - Double Door DB

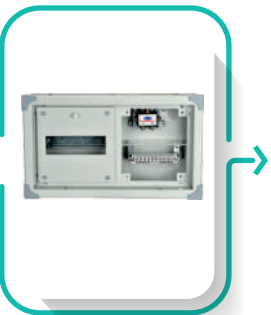

SPN Distribution Board (Suitable for DP Incoming and SP Outgoing)			TPN Distribution Board (Suitable for FP Incoming and SP Outgoing)		
No. of Ways	Item Code Double Door	MRP/Unit ₹	No. of Ways	Item Code Double Door	MRP/Unit ₹
6W	GPDSN40001	5,167/-	4W	GPDTN40001	9,524/-
8W	GPDSN40002	5,711/-	6W	GPDTN40002	10,885/-
12W	GPDSN40003	6,528/-	8W	GPDTN40003	11,834/-
16W	GPDSN40004	7,209/-	12W	GPDTN40004	12,926/-

Note: Provision for TV Splitter and Telephone Crone (Without TV Splitter & Telephone Crone).

DISTRIBUTION BOARDS

SAFETY AND COMFORT, NOW JUST A CLIQ AWAY

Polycab provides the most attractive design when it comes to Distribution Boards. Polycab Cliq Distribution Boards meet all the requirements of modern installation for domestic, commercial or industrial applications. Fabricated with utmost precision and passion The enclosures in Polycab Cliq Distribution Boards are forged from the finest quality steel which gives it a strong build and a flawless finish. The distribution boards are supplied with duly fitted Din Channel, Neutral Link, Earth Bar and Bus Bar along with detachable gland plates. So that the MCBs of desired number and rating can be fitted conveniently at site. Overall Polycab Cliq Distribution boards are a complete package that makes your wall looks classy and premium.



**Polycarbonate
Transparent Cover**



IP 42 Protection



**Incoming Power
Source Indication**



**Pressing to
Open Lock**

Polysield CLIQ SPN Consumer Distribution Board

No. of Ways	NOS OF MCB	CODE	MRP/Unit ₹
6W	I/C +O/G : 6	GPDSN50007	1,959/-
8W	I/C +O/G : 8	GPDSN50008	2,242/-
12W	I/C +O/G : 12	GPDSN50009	2,698/-
16W	I/C +O/G : 16	GPDSN50010	3,011/-

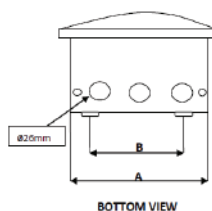
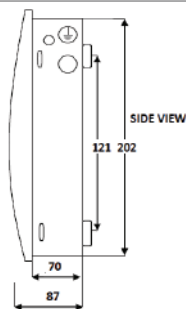
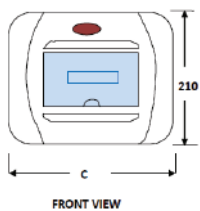

No. of Ways	A	B	C
6	205	130	214
8	258	184	268
12	322	254	338

Note: Packing (Primary / Master): 1 / 6



DECOUR DISTRIBUTION BOARDS

Polycab Designer Distribution Boards are used for the supply and control of electric installations.

More analytically they are used for

- Separating the installation in various circuits in proportion of the installed load.
- Better protection of circuits.
- Maintenance purpose, so that the rest of the circuits are not effected.
- Each circuit can be individually isolated to have uninterrupted performance under fault condition.



SALIENT FEATURES

- Plain Corner with Elegant Look
- Improved Designer Knob
- IP 43 protection with Gasket on door
- Optimise Dimension
- 180 Deg Door Opening

SPN DISTRIBUTION BOARD, DECOUR - GREY WHITE

(In accordance with IS 13032, IS 8632, IS 8623, IED / BSEN 61439-3)

RAL - 9003 grey white, IP 43 - Double Door DB



SPN Decour Distribution Board (Suitable for DP Incoming and SP Outgoing)		
No. of Ways	Item Code Double Door	MRP/Unit ₹
4W	GPDSN29W11	2,097/-
6W	GPDSN29W12	2,429/-
8W	GPDSN29W13	2,649/-
12W	GPDSN29W14	3,243/-
16W	GPDSN29W15	4,278/-

DECOUR DISTRIBUTION BOARDS

TPN DISTRIBUTION BOARD, DECOUR - GREY WHITE

(In accordance with IS 13032, IS 8632, IS 8623, IED / BSEN 61439-3)

RAL - 9003 grey white, IP 43 - Double Door DB



TPN Decour Distribution Board (Suitable for FP Incoming and SP Outgoing)			
No. of Ways	I/C + O/G Ways	Item Code Double Door	MRP/Unit ₹
4W	8 + 12	GPDTN29W41	5,210/-
6W	8 + 18	GPDTN29W42	6,298/-
8W	8 + 24	GPDTN29W43	7,939/-
12W	8 + 36	GPDTN29W44	12,118/-

SPN DISTRIBUTION BOARD, DECOUR - WOODEN TEXTURE

(In accordance with IS 13032, IS 8632, IS 8623, IED / BSEN 61439-3)

RAL - 9003 wooden texture, IP 43 - Double Door DB



SPN Decour Distribution Board (Suitable for DP Incoming and SP Outgoing)		
No. of Ways	Item Code Double Door	MRP/Unit ₹
4W	GPDSN29D11	2,727/-
6W	GPDSN29D12	3,157/-
8W	GPDSN29D13	3,444/-
12W	GPDSN29D14	4,215/-
16W	GPDSN29D15	5,561/-

TPN DISTRIBUTION BOARD, DECOUR - WOODEN TEXTURE

(In accordance with IS 13032, IS 8632, IS 8623, IED / BSEN 61439-3)

RAL - 9003 wooden texture, IP 43 - Double Door DB

TPN Decour Distribution Board (Suitable for FP Incoming and SP Outgoing)			
No. of Ways	I/C + O/G Ways	Item Code Double Door	MRP/Unit ₹
4W	8 + 12	GPDTN29D41	6,773/-
6W	8 + 18	GPDTN29D42	7,558/-
8W	8 + 24	GPDTN29D43	9,527/-
12W	8 + 36	GPDTN29D44	13,936/-

DECOUR DISTRIBUTION BOARDS

SPN DISTRIBUTION BOARD, DECOUR - GOLDEN PASSION TEXTURE

(In accordance with IS 13032, IS 8632, IS 8623, IED / BSEN 61439-3)

RAL - 9003 golden passion texture, IP 43 - Double Door DB



SPN Decour Distribution Board (Suitable for DP Incoming and SP Outgoing)		
No. of Ways	Item Code Double Door	MRP/Unit ₹
4W	GPDSN29G11	2,727/-
6W	GPDSN29G12	3,157/-
8W	GPDSN29G13	3,444/-
12W	GPDSN29G14	4,215/-
16W	GPDSN29G15	5,561/-

TPN DISTRIBUTION BOARD, DECOUR - GOLDEN PASSION TEXTURE

(In accordance with IS 13032, IS 8632, IS 8623, IED / BSEN 61439-3)

RAL - 9003 golden passion texture, IP 43 - Double Door DB



TPN Decour Distribution Board (Suitable for FP Incoming and SP Outgoing)			
No. of Ways	I/C + O/G Ways	Item Code Double Door	MRP/Unit ₹
4W	8 + 12	GPDTN29G41	6,773/-
6W	8 + 18	GPDTN29G42	7,558/-
8W	8 + 24	GPDTN29G43	9,527/-
12W	8 + 36	GPDTN29G44	13,936/-

SPN DISTRIBUTION BOARD, DECOUR - MARBLE TEXTURE

(In accordance with IS 13032, IS 8632, IS 8623, IED / BSEN 61439-3)

RAL - 9003 marble texture, IP 43 - Double Door DB

SPN Decour Distribution Board (Suitable for DP Incoming and SP Outgoing)		
No. of Ways	Item Code Double Door	MRP/Unit ₹
4W	GPDSN29M11	2727/-
6W	GPDSN29M12	3,157/-
8W	GPDSN29M13	3,444/-
12W	GPDSN29M14	4,215/-
16W	GPDSN29M15	5,561/-

DECOUR DISTRIBUTION BOARDS

TPN DISTRIBUTION BOARD, DECOUR - MARBLE TEXTURE

(In accordance with IS 13032, IS 8632, IS 8623, IED / BSEN 61439-3)

RAL - 9003 marble texture, IP 43 - Double Door DB



TPN Decour Distribution Board (Suitable for FP Incoming and SP Outgoing)			
No. of Ways	I/C + O/G Ways	Item Code Double Door	MRP/Unit ₹
4W	8 + 12	GPDTN29M41	6,773/-
6W	8 + 18	GPDTN29M42	7,558/-
8W	8 + 24	GPDTN29M43	9,527/-
12W	8 + 36	GPDTN29M44	13936/-

Note: Packing (Primary / Master): SPN (4 Way / 6 Way / 8 Way) - 1 / 6, SPN (12 Way / 16 Way) - 1 / 4.

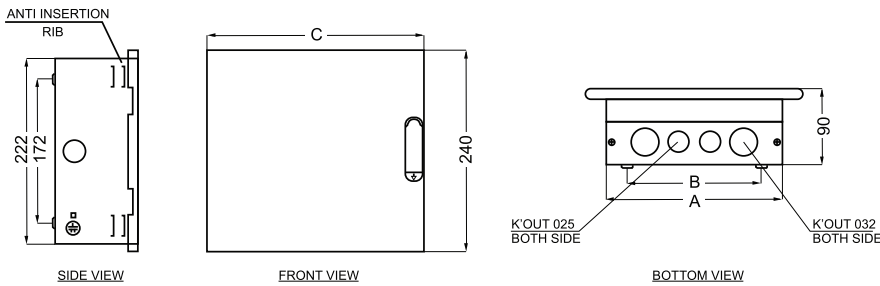

GA DRAWINGS FOR -

SPN DECOUR DB: IPN - 43 (Double Door)

WAY	A	B	C	D
04	175	125	223	72
06	210	160	258	108
08	247	197	296	144
12	317	267	365	216
16	391	341	439	288

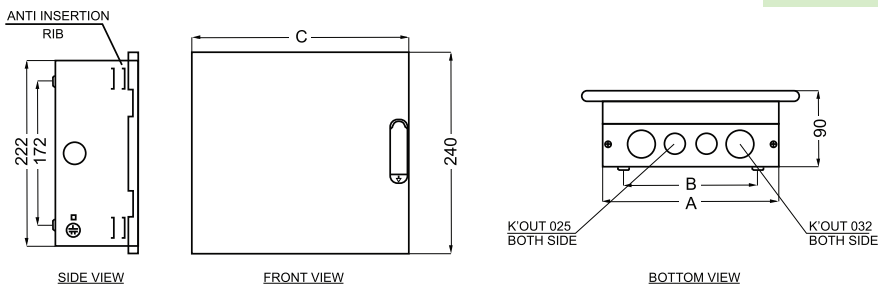

GA DRAWINGS FOR -

TPN DECOUR DB: IP-43 (Double Door)

WAY	A	B	C	D
04	315	245	360	72
06	350	280	393	108
08	400	340	442	144
12	560	490	602	216

DECOUR T BOX DISTRIBUTION BOARDS

Design To Match Your Decour

Polycab Decour T Box is a new age distribution board driven with innovation and technology. Its unique design ensures a smooth supply of power flow and distribution in homes, Offices and industries. Polycab Decour T Box distribution board comes with a transparent cover and elegant look. It also has a raised neutral bar that ensures flexibility and safety enabling safe and efficient distribution of electricity. These boards come with Top & Bottom Detachable Gland Plate with specially designed plastic knockout which is easy to install and perfectly fits and matches interiors of your home and office spaces.



Safe



Flexible



Fresh look



Easy to use

Decour T Box Transparent SPN Double Door DB

No. of Ways	NOS OF MCB	CODE	MRP / Unit ₹
8W	I/C+OG : 8	GPDSN29T13	2,935/-
11W	I/C+OG : 11	GPDSN29T16	3,622/-
14W	I/C+OG : 14	GPDSN29T17	4,509/-
19W	I/C+OG : 19	GPDSN29T18	5,248/-

Note: Packing (Primary / Master): 1 / 6

NOTES

A series of horizontal dashed lines for writing notes.

Corporate Office:

POLYCAB INDIA LIMITED

(formerly known as 'Polycab Wires Limited')

Polycab House, 771, Mogul Lane, Mahim (W), Mumbai - 400 016, Maharashtra, India. Tel: 91-22-2432 7070-4, 6735 1400

We are just a call away to answer all your queries!

Call: 1800-267-0008 **Timing:** 9:30 am to 6:30 pm (Monday - Saturday) **Email:** customercare@polycab.com

WHATSAPP: 73044 85540

www.polycab.com | email: enquiry@polycab.com | toll free no.: 1800 267 0008

Follow us on: 